

BT

ARTICOLO: **KLFR1109-000**D14.442.14.100 LENZE
BT

162 x 66 + + x 58

ELETTROFRENO CPL 20/20V.
15/50W.35-30Nm.GR.14

CATALOGO FRENI

CIMA

	ARTICOLO: KLFR1085-000			
	VARI			
	EX.13709	CIMA		
	13703	CIMA		
x + + x				
PIASTRA PORTA FRENO				

	ARTICOLO: KLFR1085-000			
	VARI			
	EX.13709	CIMA		
	13703	CIMA		
x + + x				
PIASTRA PORTA FRENO				

	ARTICOLO: KLFR1061-000			
	VARI			
	ECOR0830121104	TELECO		
	11113	CIMA		
83 x 28 + + x 37				
FRENO A MOLLE MAGNETE+ROTORE+MOZZO 12V.				

	ARTICOLO: KLFR1060-000			
	VARI			
	ECOR0830241104	TELECO		
	11114	CIMA		
83 x 28 + + x 37				
FRENO A MOLLE MAGNETE+ROTORE+MOZZO 24V.				

CATALOGO FRENI

LENZE

	ARTICOLO: KLFR1083-000
	LENZE
	50043666 SCHABMULLE P
	x + + x PIASTRA FRIZIONE FRENI 14.458.10 458/10 = BFK458

	ARTICOLO: KLFR1082-000
	LENZE
	50043597 SCHABMULLE P
	x + + x ANELLO PROTEZIONE FRENI 14.458.10 458/10 = BFK458

	ARTICOLO: KLFR1008-000
	14.449.06.0.0.4 LENZE
	14.448.08 14.458.06 BFK458-06
	25 x 10 + + x 18 MOZZO 14.449.06.0.0.4 FG IND.4 B I

	ARTICOLO: KLFR1040-000
	14.449.06.0.0.4 LENZE
	14.448.08 14.458.06 BFK458-06
	25 x 10 + + x 18 MOZZO 14.449.06.0.0.4 FF.10 IND.4 B I

	ARTICOLO: KLFR1041-000
	14.449.06.0.0.4 LENZE
	14.448.08 14.458.06 BFK458-06
	25 x 11 + + x 18 MOZZO 14.449.06.0.0.4 FF.11 IND.4 B I

	ARTICOLO: KLFR1042-000
	KE45806312 LENZE
	14.448.08 14.458.06 BFK458-06
	25 x 12 + + x 18 MOZZO 14.449.06.0.0.4 FF.12 IND.4 B I

	ARTICOLO: KLFR1043-000
	14.449.06.0.0.4 LENZE
	14.448.08 14.458.06 BFK458-06
	25 x 14 + + x 18 MOZZO 14.449.06.0.0.4 FF.14 IND.4 B I

	ARTICOLO: KLFR1044-000
	14.449.06.0.0.4 LENZE
	14.448.08 14.458.06 BFK458-06
	25 x 15 + + x 20 MOZZO 14.449.06.0.0.4 FF.15 IND.4 B I

CATALOGO FRENI

LENZE

	ARTICOLO: KLFR1045-000	
	14.449.06.0.0.4	LENZE
	14.448.08	
	14.458.06	
	BFK458-06	
	25 x 16 + + x 20	

MOZZO 14.449.06.0.0.4 FF.16
IND.4 B I

	ARTICOLO: KLFR1012-000	
	14.458.10	LENZE
	14.448.10	
	BFK458-10	
	KR4381030000C	
	35 x 10 + + x 20	

MOZZO 14.448.10./458/457
GREZZO

	ARTICOLO: KLFR1038-000	
	14.448.10	LENZE
	14.458.08	
	14.457.08	
	KR4381031400C	
	35 x 14 + + x 20	

MOZZO 14.448.10./458/457/08-
FF14

	ARTICOLO: KLFR1037-000	
	BFK458-10	LENZE
	14.458.08	
	14.457.08	
	50043636	SCHABMULLE R
	35 x 18 + + x 20	

MOZZO 14.448.10./458/457/08-
FF18 KE45810318

	ARTICOLO: KLFR1039-000	
	14.448.10	LENZE
	14.458.08	
	14.457.08	
	BFK458-08	
	35 x 20 + + x 20	

MOZZO 14.448.10./458/457/08-
FF20

	ARTICOLO: KLFR1015-000	
	KR4381230000	LENZE
	448.12	
	BFK458-12	
	40 x 14 + + x 25	
	MOZZO D.40 GREZZO 458/12	

	ARTICOLO: KLFR1068-000	
	KR4381230000	LENZE
	448.12	
	BFK458-12	
	40 x 20 + + x 25	
	MOZZO D.40 FORO 20 458/12	

	ARTICOLO: KLFR1017-000	
	KR4381430000	LENZE
	448.14	
	BFK458-14	
	45 x 14 + + x 30	
	MOZZO D.45 GREZZO 458/14	

CATALOGO FRENI

LENZE

	ARTICOLO: KLFR1063-000	
	KE45814320	LENZE
	448.14	
	BFK458-14	
	BFK457-14	
	45 x 20 + + x 30	

MOZZO D.45 14.458.14.0.0.4
FF20 458/14

	ARTICOLO: KLFR1080-000	
	KE45814322	LENZE
	448.14	
	BFK458-14	
	50043544	SCHABMULLE D
	45 x 22 + + x 30	

MOZZO D.45 14.458.14.0.0.4
FF22 458/14

	ARTICOLO: KLFR1064-000	
	KE45814325	LENZE
	448.14	
	BFK458-14	
	45 x 25 + + x 30	
	MOZZO D.45 14.458.14.0.0.4 FF25 458/14	

	ARTICOLO: KLFR1025-000	
	KR4380880030C	LENZE
	52 x 24 + + x 11	
	GHIERA REGOLAZIONE X 458/06 - 08	

	ARTICOLO: KLFR1019-000	
	KR4381630000C	LENZE
	448.16	
	BFK458-16	
	55 x 15 + + x 30	
	MOZZO D.55 GREZZO 458/16 spessore mm.30	

	ARTICOLO: KLFR1067-000	
	KE45816325	LENZE
	448.16	
	BFK458-16	
	55 x 25 + + x 30	
	MOZZO D.55 14.458.16.0.0.4 FF25 458/16	

	ARTICOLO: KLFR1024-000	
	KR4381830000C	LENZE
	448.18	
	BFK458-18	
	60 x 20 + + x 35	
	MOZZO GREZZO 458/18	

	ARTICOLO: KLFR1004-000	
	14.458.06.0.4.0	LENZE
	BFK458-06	
	60 x 25 + + x 20	
	ROTORE 14.458.06 458/06 ALLUMINIO	

CATALOGO FRENI

LENZE



ARTICOLO: **KLFR1026-000**

KR4381080030C LENZE

68 x 35 + + x 14

GHIERA REGOLAZIONE X 458/10



ARTICOLO: **KLFR1032-000**

14.448.08.04.0 LENZE
448.08

KR4380810000

76 x 25 + + x 21

ROTORE 14.448.08 FORO25 448/08



ARTICOLO: **KLFR1009-000**

14.458.08.04.0 LENZE

BFK458-08

77 x 35 + + x 21

ROTORE 14.458.08 458/08



ARTICOLO: **KLFR1027-000**

KR4381280030C LENZE

82 x 40 + + x 18

GHIERA REGOLAZIONE X 458/12



ARTICOLO: **KLFR1056-000**

457/06-6NM LENZE

84 x 31 + + x 41

FRENO A MOLLE
MAGNETE+ROTORE 457/06-6NM-24V



ARTICOLO: **KLFR1002-000**

14.458.06 LENZE

BFK458-06

85 x 32 + + x 35

MAGNETE14.458.06 TIPO E 24V A MOLLE CON GHIERA



ARTICOLO: **KLFR1003-000**

14.458.06 LENZE

E176.500 SAMAG

BFK458-06

KE4580621

85 x 32 + + x 35

MAGNETE14.458.06 TIPO E 12V A MOLLE CON GHIERA



ARTICOLO: **KLFR1011-000**

14.458.10.04.0 LENZE

00396202 LENZE

BFK458-10

50043637 SCHABMULLE
R

95 x 35 + + x 22

ROTORE 14.458.10 458/10 = BFK458

CATALOGO FRENI

LENZE

	ARTICOLO: KLFR1059-000	
	14.458.10.0.4.0	LENZE
	00396202	LENZE
	BFK458-10	
	50043637	SCHABMULLE R
	95 x 35 + + x 22	FERODO BFK458

	ARTICOLO: KLFR1059-000	
	14.458.10.0.4.0	LENZE
	00396202	LENZE
	BFK458-10	
	50043637	SCHABMULLE R
	95 x 35 + + x 22	FERODO BFK458

	ARTICOLO: KLFR1011-000	
	14.458.10.0.4.0	LENZE
	00396202	LENZE
	BFK458-10	
	50043637	SCHABMULLE R
	95 x 35 + + x 22	ROTORE 14.458.10 458/10 = BFK458

	ARTICOLO: KLFR1057-000	
	457/08-12NM	LENZE
	102 x 42 + + x 50	FRENO A MOLLE MAGNETE+ROTORE 457/08- 12NM 24V

	ARTICOLO: KLFR1034-000	
	KR4480820001	LENZE
	448.08	
	KR4480820001	
103 x 32 + + x 36	MAGNETE 12V 448/08	

	ARTICOLO: KLFR1006-000	
	14.458.08.0.1.0	LENZE
	BFK458-08	
	105 x 42 + + x 42	MAGNETE 14.458.08TIPO E12V A MOLLE CON GHIERA

	ARTICOLO: KLFR1007-000	
	14.458.08.0.1.0	LENZE
	9930532680	ORMIC
	BFK458-08	
105 x 42 + + x 42	MAGNETE 14.458.08TIPO E 24V A MOLLE CON GHIERA	

	ARTICOLO: KLFR1014-000	
	KE4581210	LENZE
	00396214	LENZE
	BFK458-12	
	50043279	SCHABMULLE R
	115 x 40 + + x 28	ROTORE D:115 FORO 40 458/12 ALLUMINIO

CATALOGO FRENI

LENZE

	ARTICOLO: KLFR1014-000	
	KE4581210	LENZE
	00396214	LENZE
	BFK458-12	
	50043279	SCHABMULLE R
	115 x 40 + + x 28	

ROTORE D.115 FORO 40
458/12 ALLUMINIO

	ARTICOLO: KLFR1031-000	
		LENZE
	123 x 40 + + x 30	
	MAGNETE 24V 437/10	

	ARTICOLO: KLFR1016-000	
	KE4581410	LENZE
	396215	LENZE
	BFK458-14	
	50043542	SCHABMULLE R
	124 x 45 + + x 31	

ROTORE D.124 FORO 45
458/14

	ARTICOLO: KLFR1016-000	
	KE4581410	LENZE
	396215	LENZE
	BFK458-14	
	50043542	SCHABMULLE R
	124 x 45 + + x 31	

ROTORE D.124 FORO 45
458/14

	ARTICOLO: KLFR1058-000	
	457/10-23NM	LENZE
	130 x 44 + + x 56	
	FRENO A MOLLE MAGNETE+ROTORE 457/10- 23NM 24V	

	ARTICOLO: KLFR1010-000	
	14.458.10.0.1.0	LENZE
	95306548	PIMESPO
	E176510	SAMAG
	BFK458-10	
	130 x 45 + + x 45	

MAGNETE KE4581020 TIPO E
24V 30W 16Nm

	ARTICOLO: KLFR1072-000	
	14.458.10.0.1.0	LENZE
	BFK458-10	
	130 x 45 + + x 45	
	MAGNETE14.458.10 TIPO E 12V A MOLLE CON GHIERA	

	ARTICOLO: KLFR1074-000	
	14.448.10.1.1.0	VARI
	BFK458-10E	
	00731967	LENZE
	50047186	SCHABMULLE R
	130 x 45 + + x 45	

ELETTROFRENO KB-EMB
SIZE10-20V

CATALOGO FRENI

LENZE



ARTICOLO: KLFR1055-000

14.458.10.0.1.0- LENZE
BFK458-10
50043958* SCHABMULLE
P
50043938 SCHABMULLE
P

130 x 45 + + x 45
MAGNETE 14.458.10 TIPO E
42V A MOLLE CON GHIERA



ARTICOLO: KLFR1013-000

14.458.12.0.1.0 LENZE
HJ0762361
BFK458-12

147 x 53 + + x 52
MAGNETE 14.458.12 TIPO E
24V A MOLLE CON GHIERA



ARTICOLO: KLFR1030-000

14.448.12.010 LENZE
448.12
BFK458-12
50043510 SCHABMULLE
P

147 x 53 + + x 51
MAGNETE 42V 448-458/12



ARTICOLO: KLFR1021-000

KE4581610 LENZE
448.16
BFK458-16

149 x 55 + + x 32
ROTORE D.150 458/16



ARTICOLO: KLFR1018-000

KE4581420 LENZE
95306771 PIMESPO
BFK458-14
448.14

162 x 61 + + x 61
MAGNETE 24V FORO 60
458/14 24V. 50W. 60Nm



ARTICOLO: KLFR1109-000

D14.442.14.100 LENZE
BT

162 x 66 + + x 58
ELETTROFRENO CPL 20/20V.
15/50W.35-30Nm.GR.14



ARTICOLO: KLFR1023-000

KE4581810 LENZE
448.18
BFK458-18

173 x 65 + + x 37
ROTORE 458/18



ARTICOLO: KLFR1028-000

KR4481620005C LENZE
448.16
KR4481620005C

187 x 71 + + x 67
MAGNETE 48V 448-458/16
42V.55W 80Nm

CATALOGO FRENI

LENZE

ARTICOLO: KLFR1020-000	
	
KE4581620	LENZE
448.16	
BFK458-16	
189 x 70 + + x 74	
MAGNETE 24V FORO 70 458/16	

ARTICOLO: KLFR1075-000	
	
KE45814	LENZE
448.14	48V.
50052994	SCHABMULLE R
50052996*	SCHABMULLE R
189 x 70 + + x 72	
MAGNETE KB-EMB GR.14-42V- 40Nm (1,5A. 34 Ohm)	

ARTICOLO: KLFR1029-000	
	
KE45816229	LENZE
448.16	
189 x 70 + + x 72	
MAGNETE 42V 458/16E 80nM	

ARTICOLO: KLFR1022-000	
	
KE4581820	LENZE
448.18	
BFK458-18	
217 x 78 + + x 82	
MAGNETE 24V 458/18 24V, 85W. 150Nm.	

CATALOGO FRENI

ORMIC

ARTICOLO: **KLFR1007-000**

14.458.08.0.1.0 LENZE

9930532680 ORMIC

BFK458-08

105 x 42 + + x 42

MAGNETE 14.458.08 TIPO E
24V A MOLLE CON GHIERA

CATALOGO FRENI

PIMESPO

ARTICOLO: **KLFR1010-000**



14.458.10.0.1.0 LENZE
 95306548 PIMESPO
 E176510 SAMAG
 BFK458-10

130 x 45 + + x 45
 MAGNETE KE4581020 TIPO E
 24V 30W 16Nm

ARTICOLO: **KLFR1018-000**



KE4581420 LENZE
 95306771 PIMESPO
 BFK458-14
 448.14

162 x 61 + + x 61
 MAGNETE 24V FORO 60
 458/14 24V. 50W. 60Nm

CATALOGO FRENI

SAMAG

ARTICOLO: **KLFR1003-000**

14.458.06 LENZE
E176.500 SAMAG
BFK458-06
KE4580621

85 x 32 + + x 35

MAGNETE 14.458.06 TIPO E
12V A MOLLE CON GHIERA



ARTICOLO: **KLFR1010-000**

14.458.10.0.1.0 LENZE
95306548 PIMESPO
E176510 SAMAG
BFK458-10

130 x 45 + + x 45

MAGNETE KE4581020 TIPO E
24V 30W 16Nm



CATALOGO FRENI

SCHABMULLER

	ARTICOLO: KLFR1083-000	
	LENZE	
	50043666	SCHABMULLE
	x + + x	
PIASTRA FRIZIONE FRENI 14.458.10 458/10 = BFK458		

	ARTICOLO: KLFR1082-000	
	LENZE	
	50043597	SCHABMULLE
	x + + x	
ANELLO PROTEZIONE FRENI 14.458.10 458/10 = BFK458		

	ARTICOLO: KLFR1086-000	
	VARI	
	KB-EMB 8BFK458	
	50044017	SCHABMULLE
0 x 0 + + x 0		
HAND-RELEASE cpl. 8BFK458		

	ARTICOLO: KLFR1037-000	
	BFK458-10	LENZE
	14.458.08 14.457.08	
	50043636	SCHABMULLE
35 x 18 + + x 20		
MOZZO 14.448.10./458/457/08- FF18 KE45810318		

	ARTICOLO: KLFR1084-000	
	KR4381230000?	VARI
	448.12 BFK458-12	
	50043421	SCHABMULLE
40 x 22 + + x 25		
MOZZO D.40 FORO 22 458/12		

	ARTICOLO: KLFR1080-000	
	KE45814322	LENZE
	448.14 BFK458-14	
	50043544	SCHABMULLE
45 x 22 + + x 30		
MOZZO D.45 14.458.14.0.0.4 FF22 458/14		

	ARTICOLO: KLFR1102-000	
	371202002	VARI
	50011291	SCHABMULLE
	79 x 23 + + x 30	
MAGNETIC SWITCH GR.3 - 24V.		

	ARTICOLO: KLFR1001-000	
	211573	VARI
	10000048 3038450	
	50018510	SCHABMULLE
79 x 23 + + x 30		
ELECTRO-MAGNETIC BRAKE SIZE3-24V.		

CATALOGO FRENI

SCHABMULLER



ARTICOLO: KLFR1011-000

14.458.10.0.4.0	LENZE
00396202	LENZE
BFK458-10	
50043637	SCHABMULLE
95 x 35 + + x 22	

ROTORE 14.458.10 458/10 = BFK458



ARTICOLO: KLFR1059-000

14.458.10.0.4.0	LENZE
00396202	LENZE
BFK458-10	
50043637	SCHABMULLE
95 x 35 + + x 22	

FERODO BFK458



ARTICOLO: KLFR1073-000

14.448.08.1.1.0	VARI
KB-EMB	
50021583	SCHABMULLE
103 x 32 + + x 36	

ELETTROFRENO CPL. KB-EMB GR.08-20V



ARTICOLO: KLFR1078-000

14.448.08.1.1.0?	VARI
KB-EMB	
50044026	SCHABMULLE
103 x 32 + + x 36	

ELETTROFRENO CPL. KB-EMB BFK458-8E-20V-11H7



ARTICOLO: KLFR1014-000

KE4581210	LENZE
00396214	LENZE
BFK458-12	
50043279	SCHABMULLE
115 x 40 + + x 28	

ROTORE D.115 FORO 40 458/12 ALLUMINIO



ARTICOLO: KLFR1016-000

KE4581410	LENZE
396215	LENZE
BFK458-14	
50043542	SCHABMULLE
124 x 45 + + x 31	

ROTORE D.124 FORO 45 458/14



ARTICOLO: KLFR1055-000

14.458.10.0.1.0-	LENZE
BFK458-10	
50043958*	SCHABMULLE
50043938	SCHABMULLE
130 x 45 + + x 45	

MAGNETE 14.458.10 TIPO E 42V A MOLLE CON GHIERA



ARTICOLO: KLFR1055-000

14.458.10.0.1.0-	LENZE
BFK458-10	
50043958*	SCHABMULLE
50043938	SCHABMULLE
130 x 45 + + x 45	

MAGNETE 14.458.10 TIPO E 42V A MOLLE CON GHIERA

CATALOGO FRENI

SCHABMULLER



ARTICOLO: KLFR1074-000

14.448.10.1.1.0	VARI
BFK458-10E	
00731967	LENZE
50047186	SCHABMULLE P
130 x 45 +	+ x 45

ELETTROFRENO KB-EMB
SIZE10-20V



ARTICOLO: KLFR1030-000

14.448.12.010	LENZE
448.12	
BFK458-12	
50043510	SCHABMULLE P
147 x 53 +	+ x 51

MAGNETE 42V 448-458/12



ARTICOLO: KLFR1112-000

BFK457-14-48V	VARI
KB-EMB	
11000104	SCHABMULLE P
165 x 60 +	+ x 77

ELETTROFRENO CPL. KB-EMB
BFK457-14-48V-30H7



ARTICOLO: KLFR1075-000

KE45814	LENZE
448.14	48V.
50052994	SCHABMULLE P
50052996*	SCHABMULLE P
189 x 70 +	+ x 72

MAGNETE KB-EMB GR.14-42V-40Nm (1,5A. 34 Ohm)



ARTICOLO: KLFR1075-000

KE45814	LENZE
448.14	48V.
50052994	SCHABMULLE P
50052996*	SCHABMULLE P
189 x 70 +	+ x 72

MAGNETE KB-EMB GR.14-42V-40Nm (1,5A. 34 Ohm)

CATALOGO FRENI

TELECO

ARTICOLO: **KLFR1061-000**

VARI

ECOR0830121104 TELECO

11113 CIMA

83 x 28 + + x 37

FRENO A MOLLE
MAGNETE+ROTORE+MOZZO
12V.ARTICOLO: **KLFR1060-000**

VARI

ECOR0830241104 TELECO

11114 CIMA

83 x 28 + + x 37

FRENO A MOLLE
MAGNETE+ROTORE+MOZZO
24V.ARTICOLO: **KLFR1081-000**

VARI

SECOR1020241405 TELECO

102 x 39 + + x 76

FRENO SECOR 102
+ROTORE+MOZZO 24V.ARTICOLO: **KLFR1110-000**

VARI

SECOR125024XXY TELECO

v

127 x 47 + + x 95

FRENO SECOR 125
+ROTORE+MOZZO 24V.ARTICOLO: **KLFR1111-000**

VARI

FMPR145024XXYY TELECO

145 x 52 + + x 113

FRENO FMPR 145
+ROTORE+MOZZO 24V.

CATALOGO FRENI

VARI

	ARTICOLO: KLFR1085-000	
	VARI	
	EX.13709	CIMA
	13703	CIMA
	x + + x	
PIASTRA PORTA FRENO		

	ARTICOLO: KLFR1105-000	
	KE4582020	VARI
	448.20	
	BFK458-20	
	0 x 0 + + x 0	
MAGNETE 24V 458/20		

	ARTICOLO: KLFR1088-000	
	VARI	
	KB-EMB	
	12BFK458	
	50043357	
0 x 0 + + x 0		
HAND-RELEASE cpl. 12BFK458		

	ARTICOLO: KLFR1087-000	
	VARI	
	KB-EMB	
	10BFK458	
	50043598	
0 x 0 + + x 0		
HAND-RELEASE cpl. 10BFK458		

	ARTICOLO: KLFR1086-000	
	VARI	
	KB-EMB	
	8BFK458	
	50044017	SCHABMULLE R
0 x 0 + + x 0		
HAND-RELEASE cpl. 8BFK458		

	ARTICOLO: KLFR1106-000	
	KE4582010	VARI
	448.20	
	BFK458-20	
	0 x 0 + + x 0	
ROTORE 458/20		

	ARTICOLO: KLFR1054-000	
	14.448.10	VARI
	14.458.08	
	14.457.08	
	BFK458-08	
35 x 15 + + x 20		
MOZZO 14.448.10/458/457/08- FF15 -KR4381031500C		

	ARTICOLO: KLFR1095-000	
	BFK458-10	VARI
	14.458.08	
	14.457.08	
	35 x 16 + + x 20	
MOZZO 14.448.10/458/457/08- FF16		

CATALOGO FRENI

VARI

ARTICOLO: KLFR1084-000



KR4381230000? VARI
448.12
BFK458-12
50043421 SCHABMULLE
R
40 x 22 + + x 25
MOZZO D.40 FORO 22 458/12

ARTICOLO: KLFR1046-004



VARI
0901153
45,5 x 18 + + x 16
MOZZO 15 DENTI XFR
MEC80=T90

ARTICOLO: KLFR1097-004



VARI
0901152
45,5 x 18 + + x 30
MOZZO 15 DENTI XFR
MEC63D=T70D

ARTICOLO: KLFR1099-004



VARI
0901157
45,5 x 24 + + x 16
MOZZO 15 DENTI XFR
MEC90=T100

ARTICOLO: KLFR1103-000



KE45816330?? VARI
448.16
BFK458-16
55 x 30 + + x 30
MOZZO D.55 14.458.16.0.0.4
FF30 458/16

ARTICOLO: KLFR1107-000



VARI
448.20
BFK458-20
60 x 20 + + x 35
MOZZO GREZZO 458/20

ARTICOLO: KLFR1065-004



VARI
60 x 22 + + x 19
ROTORE-FERODO

ARTICOLO: KLFR1102-000



371202002 VARI
50011291 SCHABMULLE
R
79 x 23 + + x 30
MAGNETIC SWITCH GR.3 -
24V.

CATALOGO FRENI

VARI

ARTICOLO: KLFR1001-000	
	
211573	VARI
10000048	
3038450	
50018510	SCHABMULLE
	R
79 x 23 +	+ x 30
ELECTRO-MAGNETIC BRAKE SIZE3-24V.	

ARTICOLO: KLFR1061-000	
	
	VARI
ECOR0830121104	TELECO
11113	CIMA
83 x 28 +	+ x 37
FRENO A MOLLE MAGNETE+ROTORE+MOZZO 12V.	

ARTICOLO: KLFR1060-000	
	
	VARI
ECOR0830241104	TELECO
11114	CIMA
83 x 28 +	+ x 37
FRENO A MOLLE MAGNETE+ROTORE+MOZZO 24V.	

ARTICOLO: KLFR1081-000	
	
	VARI
SECOR1020241405	TELECO
102 x 39 +	+ x 76
FRENO SECOR 102 +ROTORE+MOZZO 24V.	

ARTICOLO: KLFR1078-000	
	
14.448.08.1.1.0?	VARI
KB-EMB	
50044026	SCHABMULLE
	R
103 x 32 +	+ x 36
ELETTROFRENO CPL. KB- EMB BFK458-8E-20V-11H7	

ARTICOLO: KLFR1073-000	
	
14.448.08.1.1.0	VARI
KB-EMB	
50021583	SCHABMULLE
	R
103 x 32 +	+ x 36
ELETTROFRENO CPL. KB- EMB GR.08-20V	

ARTICOLO: KLFR1098-004	
	
	VARI
124 x 46,5 +	+ x 13
ROTORE-FERODO XFR MEC80- T90 A 15 DENTI	

ARTICOLO: KLFR1110-000	
	
	VARI
SECOR125024XXY	TELECO
127 x 47 +	+ x 95
FRENO SECOR 125 +ROTORE+MOZZO 24V.	

CATALOGO FRENI

VARI

	ARTICOLO: KLFR1074-000	
	14.448.10.1.1.0	VARI
	BFK458-10E	
	00731967	LENZE
	50047186	SCHABMULLE R
130 x 45 + + x 45	ELETTROFRENO KB-EMB SIZE10-20V	

	ARTICOLO: KLFR1089-004	
	VARI	
	137 x 60 + + x	
	MAGNETE X FR MGM MEC71	

	ARTICOLO: KLFR1051-004	
	VARI	
	144 x + + x 36	
	MAGNETE XFR 230/400V. T80	

	ARTICOLO: KLFR1111-000	
	VARI	
	FMPR145024XXYY TELECO	
	145 x 52 + + x 113	
	FRENO FMPR 145 +ROTORE+MOZZO 24V.	

	ARTICOLO: KLFR1090-004	
	VARI	
	154 x 70 + + x	
	MAGNETE X FR MGM MEC80	

	ARTICOLO: KLFR1112-000	
	BFK457-14-48V	VARI
	KB-EMB	
	11000104	SCHABMULLE R
	165 x 60 + + x 77	ELETTROFRENO CPL. KB-EMB BFK457-14-48V-30H7

	ARTICOLO: KLFR1049-004	
	VARI	
	172 x + + x 41	
	MAGNETE XFR 230/400V. T90	

	ARTICOLO: KLFR1091-004	
	VARI	
	174 x 80 + + x	
	MAGNETE X FR MGM MEC90	

CATALOGO FRENI

VARI

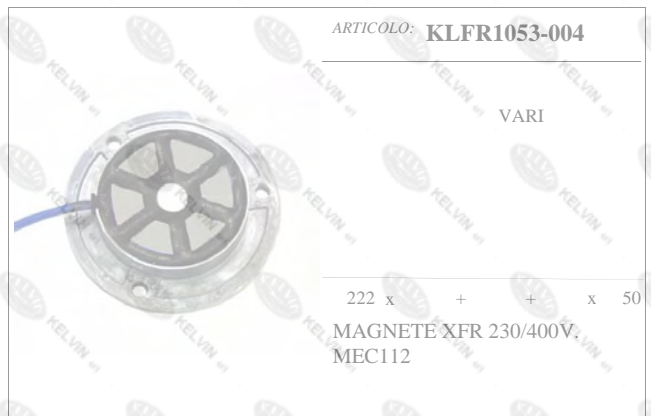
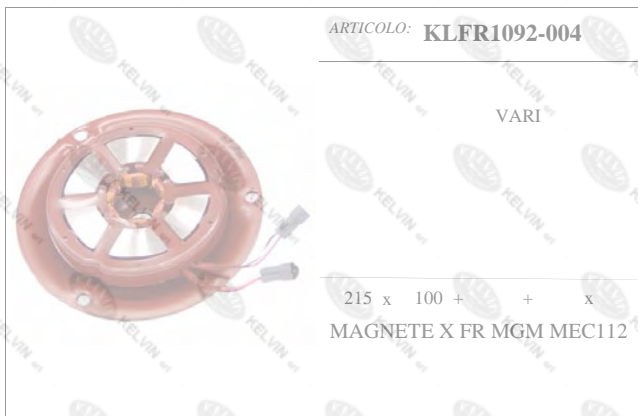
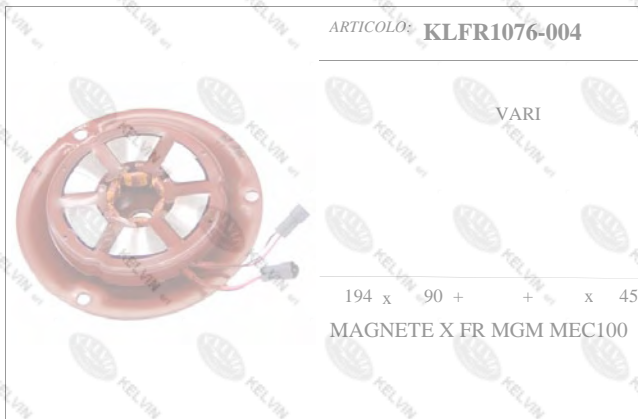
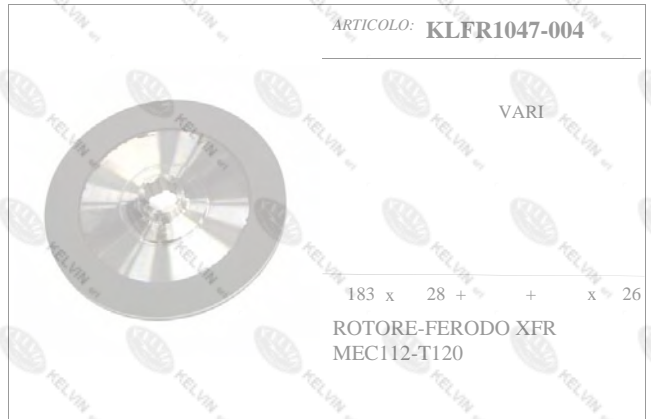

CATALOGO FRENI

VARI

