

# CATALOGO FRENI

## LENZE

	ARTICOLO: <b>KLFR1083-000</b>
	LENZE
	50043666 SCHABMULLE P
	x + + x PIASTRA FRIZIONE FRENI 14.458.10 458/10 = BFK458

	ARTICOLO: <b>KLFR1082-000</b>
	LENZE
	50043597 SCHABMULLE P
	x + + x ANELLO PROTEZIONE FRENI 14.458.10 458/10 = BFK458

	ARTICOLO: <b>KLFR1008-000</b>
	14.449.06.0.0.4 LENZE
	14.448.08 14.458.06 BFK458-06
	25 x 10 + + x 18 MOZZO 14.449.06.0.0.4 FG IND.4 B I

	ARTICOLO: <b>KLFR1040-000</b>
	14.449.06.0.0.4 LENZE
	14.448.08 14.458.06 BFK458-06
	25 x 10 + + x 18 MOZZO 14.449.06.0.0.4 FF.10 IND.4 B I

	ARTICOLO: <b>KLFR1041-000</b>
	14.449.06.0.0.4 LENZE
	14.448.08 14.458.06 BFK458-06
	25 x 11 + + x 18 MOZZO 14.449.06.0.0.4 FF.11 IND.4 B I

	ARTICOLO: <b>KLFR1042-000</b>
	KE45806312 LENZE
	14.448.08 14.458.06 BFK458-06
	25 x 12 + + x 18 MOZZO 14.449.06.0.0.4 FF.12 IND.4 B I

	ARTICOLO: <b>KLFR1043-000</b>
	14.449.06.0.0.4 LENZE
	14.448.08 14.458.06 BFK458-06
	25 x 14 + + x 18 MOZZO 14.449.06.0.0.4 FF.14 IND.4 B I

	ARTICOLO: <b>KLFR1044-000</b>
	14.449.06.0.0.4 LENZE
	14.448.08 14.458.06 BFK458-06
	25 x 15 + + x 20 MOZZO 14.449.06.0.0.4 FF.15 IND.4 B I

# CATALOGO FRENI

## LENZE

	<b>ARTICOLO: KLFR1045-000</b>	
	14.449.06.0.0.4	LENZE
	14.448.08	
	14.458.06	
	BFK458-06	
25 x 16 + + x 20		
MOZZO 14.449.06.0.0.4 FF.16 IND.4 B I		

	<b>ARTICOLO: KLFR1012-000</b>	
	14.458.10	LENZE
	14.448.10	
	BFK458-10	
	KR4381030000C	
35 x 10 + + x 20		
MOZZO 14.448.10./458/457 GREZZO		

	<b>ARTICOLO: KLFR1038-000</b>	
	14.448.10	LENZE
	14.458.08	
	14.457.08	
	KR4381031400C	
35 x 14 + + x 20		
MOZZO 14.448.10./458/457/08- FF14		

	<b>ARTICOLO: KLFR1037-000</b>	
	BFK458-10	LENZE
	14.458.08	
	14.457.08	
	50043636	SCHABMULLE R
35 x 18 + + x 20		
MOZZO 14.448.10./458/457/08- FF18 KE45810318		

	<b>ARTICOLO: KLFR1039-000</b>	
	14.448.10	LENZE
	14.458.08	
	14.457.08	
	BFK458-08	
35 x 20 + + x 20		
MOZZO 14.448.10./458/457/08- FF20		

	<b>ARTICOLO: KLFR1015-000</b>	
	KR4381230000	LENZE
	448.12	
	BFK458-12	
	40 x 14 + + x 25	
MOZZO D.40 GREZZO 458/12		

	<b>ARTICOLO: KLFR1068-000</b>	
	KR4381230000	LENZE
	448.12	
	BFK458-12	
	40 x 20 + + x 25	
MOZZO D.40 FORO 20 458/12		

	<b>ARTICOLO: KLFR1017-000</b>	
	KR4381430000	LENZE
	448.14	
	BFK458-14	
	45 x 14 + + x 30	
MOZZO D.45 GREZZO 458/14		

# CATALOGO FRENI

## LENZE

	<b>ARTICOLO: KLFR1063-000</b>	
	KE45814320	LENZE
	448.14	
	BFK458-14	
	BFK457-14	
	45 x 20 + + x 30	

MOZZO D.45 14.458.14.0.0.4  
FF20 458/14

	<b>ARTICOLO: KLFR1080-000</b>	
	KE45814322	LENZE
	448.14	
	BFK458-14	
	50043544	SCHABMULLE D
	45 x 22 + + x 30	

MOZZO D.45 14.458.14.0.0.4  
FF22 458/14

	<b>ARTICOLO: KLFR1064-000</b>	
	KE45814325	LENZE
	448.14	
	BFK458-14	
	45 x 25 + + x 30	
	MOZZO D.45 14.458.14.0.0.4 FF25 458/14	

	<b>ARTICOLO: KLFR1025-000</b>	
	KR4380880030C	LENZE
	52 x 24 + + x 11	
	GHIERA REGOLAZIONE X 458/06 - 08	

	<b>ARTICOLO: KLFR1019-000</b>	
	KR4381630000C	LENZE
	448.16	
	BFK458-16	
	55 x 15 + + x 30	
	MOZZO D.55 GREZZO 458/16 spessore mm.30	

	<b>ARTICOLO: KLFR1067-000</b>	
	KE45816325	LENZE
	448.16	
	BFK458-16	
	55 x 25 + + x 30	
	MOZZO D.55 14.458.16.0.0.4 FF25 458/16	

	<b>ARTICOLO: KLFR1024-000</b>	
	KR4381830000C	LENZE
	448.18	
	BFK458-18	
	60 x 20 + + x 35	
	MOZZO GREZZO 458/18	

	<b>ARTICOLO: KLFR1004-000</b>	
	14.458.06.0.4.0	LENZE
	BFK458-06	
	60 x 25 + + x 20	
	ROTORE 14.458.06 458/06 ALLUMINIO	

# CATALOGO FRENI

## LENZE



ARTICOLO: **KLFR1026-000**

KR4381080030C    LENZE

68 x 35 +    +    x 14

GHIERA REGOLAZIONE X 458/10



ARTICOLO: **KLFR1032-000**

14.448.08.04.0    LENZE  
448.08

KR4380810000

76 x 25 +    +    x 21

ROTORE 14.448.08 FORO25 448/08



ARTICOLO: **KLFR1009-000**

14.458.08.04.0    LENZE

BFK458-08

77 x 35 +    +    x 21

ROTORE 14.458.08 458/08



ARTICOLO: **KLFR1027-000**

KR4381280030C    LENZE

82 x 40 +    +    x 18

GHIERA REGOLAZIONE X 458/12



ARTICOLO: **KLFR1056-000**

457/06-6NM    LENZE

84 x 31 +    +    x 41

FRENO A MOLLE  
MAGNETE+ROTORE 457/06-6NM-24V



ARTICOLO: **KLFR1002-000**

14.458.06    LENZE

BFK458-06

85 x 32 +    +    x 35

MAGNETE14.458.06 TIPO E 24V A MOLLE CON GHIERA



ARTICOLO: **KLFR1003-000**

14.458.06    LENZE

E176.500    SAMAG

BFK458-06

KE4580621

85 x 32 +    +    x 35

MAGNETE14.458.06 TIPO E 12V A MOLLE CON GHIERA



ARTICOLO: **KLFR1011-000**

14.458.10.04.0    LENZE

00396202    LENZE

BFK458-10

50043637    SCHABMULLE  
R

95 x 35 +    +    x 22

ROTORE 14.458.10 458/10 = BFK458

# CATALOGO FRENI

## LENZE

	<b>ARTICOLO: KLFR1059-000</b>	
	14.458.10.0.4.0	LENZE
	00396202	LENZE
	BFK458-10	
	50043637	SCHABMULLE R
	95 x 35 + + x 22	FERODO BFK458

	<b>ARTICOLO: KLFR1059-000</b>	
	14.458.10.0.4.0	LENZE
	00396202	LENZE
	BFK458-10	
	50043637	SCHABMULLE R
	95 x 35 + + x 22	FERODO BFK458

	<b>ARTICOLO: KLFR1011-000</b>	
	14.458.10.0.4.0	LENZE
	00396202	LENZE
	BFK458-10	
	50043637	SCHABMULLE R
	95 x 35 + + x 22	ROTORE 14.458.10 458/10 = BFK458

	<b>ARTICOLO: KLFR1057-000</b>	
	457/08-12NM	LENZE
	102 x 42 + + x 50	FRENO A MOLLE MAGNETE+ROTORE 457/08- 12NM 24V

	<b>ARTICOLO: KLFR1034-000</b>	
	KR4480820001	LENZE
	448.08	
	KR4480820001	
	103 x 32 + + x 36	MAGNETE 12V 448/08

	<b>ARTICOLO: KLFR1006-000</b>	
	14.458.08.0.1.0	LENZE
	BFK458-08	
	105 x 42 + + x 42	MAGNETE 14.458.08TIPO E12V A MOLLE CON GHIERA

	<b>ARTICOLO: KLFR1007-000</b>	
	14.458.08.0.1.0	LENZE
	9930532680	ORMIC
	BFK458-08	
	105 x 42 + + x 42	MAGNETE 14.458.08TIPO E 24V A MOLLE CON GHIERA

	<b>ARTICOLO: KLFR1014-000</b>	
	KE4581210	LENZE
	00396214	LENZE
	BFK458-12	
	50043279	SCHABMULLE R
	115 x 40 + + x 28	ROTORE D:115 FORO 40 458/12 ALLUMINIO

# CATALOGO FRENI

## LENZE

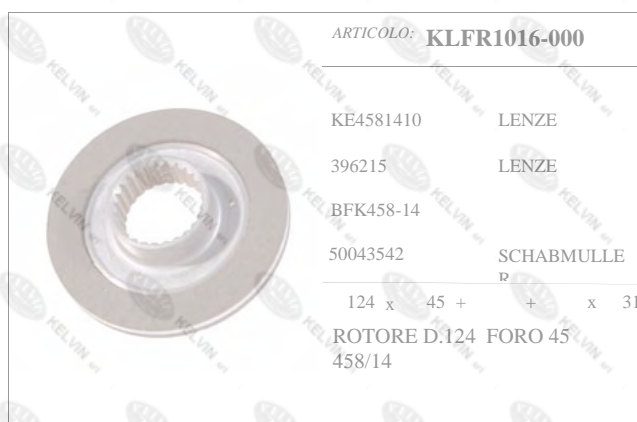
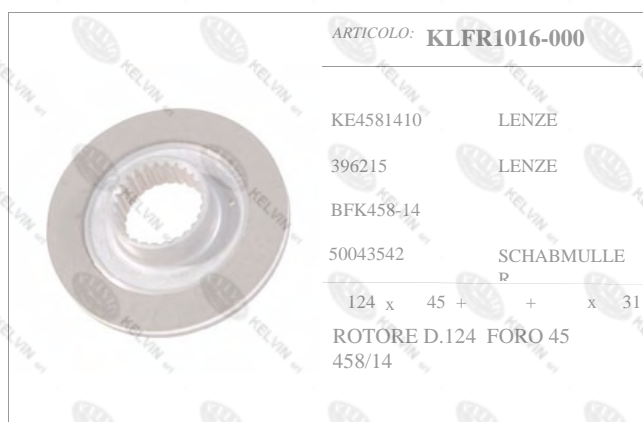
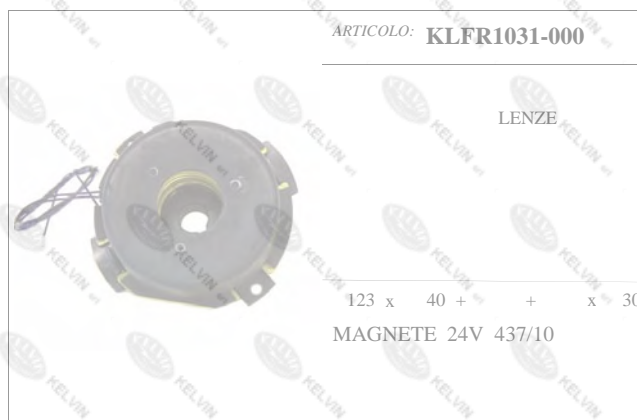

# CATALOGO FRENI

## LENZE



**ARTICOLO: KLFR1055-000**

14.458.10.0.1.0- LENZE  
BFK458-10  
50043958\* SCHABMULLE  
P  
50043938 SCHABMULLE  
P

130 x 45 + + x 45  
MAGNETE 14.458.10 TIPO E  
42V A MOLLE CON GHIERA



**ARTICOLO: KLFR1013-000**

14.458.12.0.1.0 LENZE  
HJ0762361  
BFK458-12

147 x 53 + + x 52  
MAGNETE 14.458.12 TIPO E  
24V A MOLLE CON GHIERA



**ARTICOLO: KLFR1030-000**

14.448.12.010 LENZE  
448.12  
BFK458-12  
50043510 SCHABMULLE  
P

147 x 53 + + x 51  
MAGNETE 42V 448-458/12



**ARTICOLO: KLFR1021-000**

KE4581610 LENZE  
448.16  
BFK458-16

149 x 55 + + x 32  
ROTORE D.150 458/16



**ARTICOLO: KLFR1018-000**

KE4581420 LENZE  
95306771 PIMESPO  
BFK458-14  
448.14

162 x 61 + + x 61  
MAGNETE 24V FORO 60  
458/14 24V. 50W. 60Nm



**ARTICOLO: KLFR1109-000**

D14.442.14.100 LENZE  
BT

162 x 66 + + x 58  
ELETTROFRENO CPL 20/20V.  
15/50W.35-30Nm.GR.14



**ARTICOLO: KLFR1023-000**

KE4581810 LENZE  
448.18  
BFK458-18

173 x 65 + + x 37  
ROTORE 458/18



**ARTICOLO: KLFR1028-000**

KR4481620005C LENZE  
448.16  
KR4481620005C

187 x 71 + + x 67  
MAGNETE 48V 448-458/16  
42V.55W 80Nm

# CATALOGO FRENI

## LENZE

	<b>ARTICOLO: KLFR1020-000</b>	
	KE4581620	LENZE
	448.16	
	BFK458-16	
189 x 70 + + x 74		
MAGNETE 24V FORO 70 458/16		

	<b>ARTICOLO: KLFR1075-000</b>	
	KE45814	LENZE
	448.14	48V.
	50052994	SCHABMULLE R
50052996*	SCHABMULLE R	
189 x 70 + + x 72		
MAGNETE KB-EMB GR.14-42V- 40Nm (1,5A. 34 Ohm)		

	<b>ARTICOLO: KLFR1029-000</b>	
	KE45816229	LENZE
	448.16	
189 x 70 + + x 72		
MAGNETE 42V 458/16E 80nM		

	<b>ARTICOLO: KLFR1022-000</b>	
	KE4581820	LENZE
	448.18	
	BFK458-18	
217 x 78 + + x 82		
MAGNETE 24V 458/18 24V, 85W. 150Nm.		