

CATALOGO MOTORI



CODICE: **KLMT1602-**

11214009
0136350009
=30551



ROTAZIONE V.L.A.: Entrambi i sensi

Ø 112 X 180 mors 3

CARR.: **SALPAANCORE LOFRANS**

MOTORE: **BOSCH**

TIPO: **AMJ4656<=>C**

ARM. V1: 12 A1:

ECC.: **SERIE**

V2: A2:

KW: 1 HP

U./MIN: 3100

APPLIC.: **NAUTICA**

SERV: **S3**

CODICE: **KLMT1603-**

11214010
0136350010
EX.01363500



ROTAZIONE V.L.A.: Entrambi i sensi

Ø 112 X 180 mors 3

CARR.: **SALPAANCORE LOFRANS**

MOTORE: **BOSCH**

TIPO: **AMJ4657<=>C**

ARM. V1: 24 A1:

ECC.: **SERIE**

V2: A2:

KW: 1 HP

U./MIN: 3200

APPLIC.: **NAUTICA**

SERV: **S3**

CODICE: **KLMT3388-**

30564



ROTAZIONE V.L.A.: Entrambi i sensi

Ø 114 X 168 mors 3

CARR.: **SALPAANCORE ARGANO MA**

MOTORE: **CIMA**

TIPO: **30564- Albero d.14**

ARM. V1: 12 A1: 60

ECC.: **SERIE**

V2: A2:

KW: 1,000 HP

U./MIN: 3200

APPLIC.: **NAUTICA**

SERV: **INT.**

CODICE: **KLMT3253-**

30370

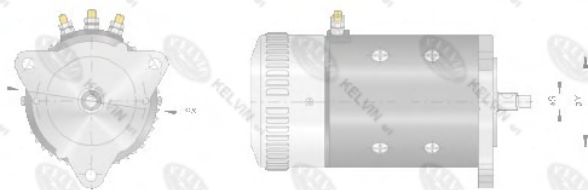

ROTAZIONE V.L.A.: Entrambi i sensi

Ø 127 X 0 mors 3

CARR.: **SALPAANCORE ARGANO**

MOTORE: **CIMA**

TIPO: **30370- Albero d.17**

ARM. V1: 12 A1:

ECC.: **SERIE**

V2: A2:

KW: 1,500 HP

U./MIN: 3000

APPLIC.: **NAUTICA**

SERV:

CODICE: **KLMT3250-**

30904

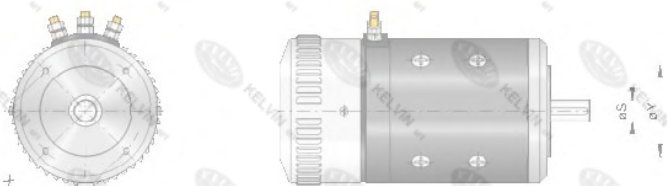

ROTAZIONE V.L.A.: Entrambi i sensi

Ø 127 X 0 mors 3

CARR.: **SALPAANCORE ARGANO**

MOTORE: **CIMA**

TIPO: **30904- Albero d.14**

ARM. V1: 12 A1:

ECC.: **SERIE**

V2: A2:

KW: 1,500 HP

U./MIN: 3000

APPLIC.: **NAUTICA**

SERV:

CATALOGO MOTORI



SRL

CODICE: **KLMT3249-**

30389

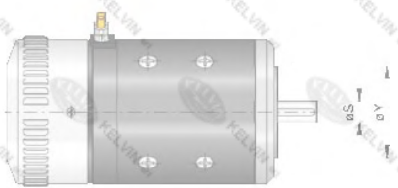
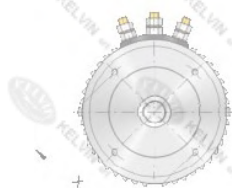

ROTAZIONE V.L.A.: Entrambi i sensi

∅ 127 X 0 mors 3

CARR.: **SALPAANCORE ARGANO**

MOTORE: **CIMA**

TIPO: **30389- Albero d.19**

ARM. V1: **12** A1:

ECC.: **SERIE**

V2: A2:

KW: **1,500** HP

U./MIN: **3000**

APPLIC.: **NAUTICA**

SERV:

CODICE: **KLMT3239-**

30807



ROTAZIONE V.L.A.: Entrambi i sensi

∅ 95 X 162 mors 2

CARR.: **SALPAANCORE ARGANO**

MOTORE: **CIMA**

TIPO: **30807 - Albero d.14**

ARM. V1: **12** A1: **0**

ECC.: **M. PERMANENTE**

V2: A2:

KW: **0,700** HP

U./MIN:

APPLIC.: **NAUTICA**

SERV:

CODICE: **KLMT3152-**

30551



ROTAZIONE V.L.A.: Entrambi i sensi

∅ 114 X 175 mors 3

CARR.: **SALPAANCORE ARGANO**

MOTORE: **CIMA**

TIPO: **30551**

ARM. V1: **12** A1: **124**

ECC.: **SERIE**

V2: A2:

KW: **1** HP

U./MIN: **3000**

APPLIC.: **NAUTICA**

SERV: **S3**

CODICE: **KLMT3261-**

30589



ROTAZIONE V.L.A.: Entrambi i sensi

∅ 82 X 157 mors 2

CARR.: **SALPAANCORE ARGANO**

MOTORE: **CIMA**

TIPO: **30589- Albero d.11**

ARM. V1: **12** A1: **51**

ECC.: **M. PERMANENTE**

V2: A2:

KW: **0,400** HP

U./MIN: **3000**

APPLIC.: **NAUTICA**

SERV:

CODICE: **KLMT3263-**

30572



ROTAZIONE V.L.A.: Entrambi i sensi

∅ 82 X 0 mors 3

CARR.: **SALPAANCORE ARGANO**

MOTORE: **CIMA**

TIPO: **30572- Albero d.11**

ARM. V1: **12** A1: **0**

ECC.: **SERIE**

V2: A2:

KW: **0,500** HP

U./MIN:

APPLIC.: **NAUTICA**

SERV:

CATALOGO MOTORI



SRL

CODICE: **KLMT3243-**

30566



ROTAZIONE V.L.A.: Entrambi i sensi

Ø 114 X 182 mors 3

CARR.: **SALPAANCORE ARGANO**

MOTORE: **CIMA**

TIPO: **30566 - Albero d.14**

ARM. V1: **12** A1: **146**

ECC.: **SERIE**

V2: A2:

KW: **1,200** HP

U./MIN: **2700**

APPLIC.: **NAUTICA**

SERV:

CODICE: **KLMT3090-**

30559



ROTAZIONE V.L.A.: Entrambi i sensi

Ø 95 X 150 mors 3

CARR.: **SALPAANCORE ARGANO**

MOTORE: **CIMA**

TIPO: **30559**

ARM. V1: **12** A1: **105**

ECC.: **SERIE**

V2: A2:

KW: **0,700** HP

U./MIN: **2800**

APPLIC.: **NAUTICA**

SERV:

CODICE: **KLMT3242-**

30582



ROTAZIONE V.L.A.: Entrambi i sensi

Ø 114 X 178 mors 3

CARR.: **SALPAANCORE ARGANO**

MOTORE: **CIMA**

TIPO: **30582 - Albero d.14**

ARM. V1: **12** A1: **146**

ECC.: **SERIE**

V2: A2:

KW: **1,200** HP

U./MIN: **2700**

APPLIC.: **NAUTICA**

SERV:

CODICE: **KLMT2904-**

30808



ROTAZIONE V.L.A.: Entrambi i sensi

Ø 114 X 160 mors 2

CARR.: **SALPAANCORE ARGANO**

MOTORE: **CIMA**

TIPO: **30808**

ARM. V1: **12** A1: **0**

ECC.: **M. PERMANENTE**

V2: A2:

KW: **1** HP

U./MIN: **0**

APPLIC.: **NAUTICA**

SERV:

CODICE: **KLMT2350-**

30553



ROTAZIONE V.L.A.: Entrambi i sensi

Ø 114 X 160 mors 3

CARR.: **SALPAANCORE ARGANO**

MOTORE: **CIMA**

TIPO: **30553 - Albero d.14**

ARM. V1: **12** A1: **124**

ECC.: **SERIE**

V2: A2:

KW: **1** HP

U./MIN: **3000**

APPLIC.: **NAUTICA**

SERV:

CATALOGO MOTORI



SRL

CODICE: **KLMT3241-**

30924



ROTAZIONE V.L.A.: Entrambi i sensi

Ø 114 X 160 morsi 3

CARR.: **SALPAANCORE ARGANO**

MOTORE: **CIMA**

TIPO: **30924 - Albero d.14**

ARM. V1: **12** A1: **124**

ECC.: **SERIE**

V2: A2:

KW: **1** HP

U./MIN: **3000**

APPLIC.: **NAUTICA**

SERV:

CODICE: **KLMT3394-**

30548



ROTAZIONE V.L.A.: Entrambi i sensi

Ø 82 X 0 morsi 2

CARR.: **SALPAANCORE ARGANO**

MOTORE: **CIMA**

TIPO: **30548 - Albero d.11**

ARM. V1: **12** A1: **51**

ECC.: **M. PERMANENTE**

V2: A2:

KW: **0,400/0,60** HP

U./MIN: **3000**

APPLIC.: **NAUTICA**

SERV:

CODICE: **KLMT3264-**

30549

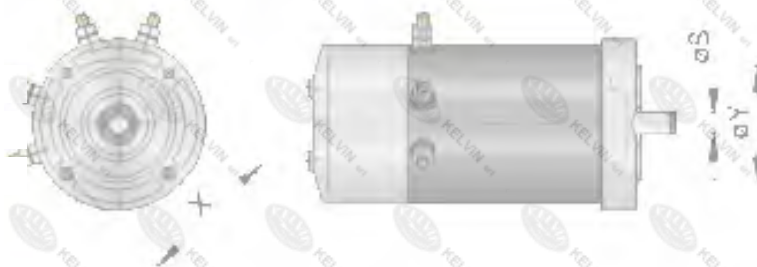

ROTAZIONE V.L.A.: Entrambi i sensi

Ø 82 X 0 morsi 2

CARR.: **SALPAANCORE ARGANO**

MOTORE: **CIMA**

TIPO: **30549 - Albero d.11**

ARM. V1: **12** A1: **0**

ECC.: **M. PERMANENTE**

V2: A2:

KW: **0,400 - 0,6** HP

U./MIN:

APPLIC.: **NAUTICA**

SERV:

CODICE: **KLMT2707-**

30557



ROTAZIONE V.L.A.: Entrambi i sensi

Ø 114 X 175 morsi 3

CARR.: **SALPAANCORE ARGANO**

MOTORE: **CIMA**

TIPO: **30557**

ARM. V1: **12** A1: **146**

ECC.: **SERIE**

V2: A2:

KW: **1,200** HP

U./MIN: **2700**

APPLIC.: **NAUTICA**

SERV:

CODICE: **KLMT3246-**

30925



ROTAZIONE V.L.A.: Entrambi i sensi

Ø 114 X 160 morsi 3

CARR.: **SALPAANCORE ARGANO**

MOTORE: **CIMA**

TIPO: **30925 - Albero d.14**

ARM. V1: **24** A1:

ECC.: **SERIE**

V2: A2:

KW: **1,000** HP

U./MIN: **3000**

APPLIC.: **NAUTICA**

SERV:

CATALOGO MOTORI



SRL

CODICE: **KLMT3240-**

30814



ROTAZIONE V.L.A.: Entrambi i sensi

∅ 95 X 0 morsi 2

CARR.: **SALPAANCORE ARGANO**

MOTORE: **CIMA**

TIPO: **30814 - Albero d.14**

ARM. V1: **24** A1: **0**

ECC.: **M. PERMANENTE**

V2: A2:

KW: **0,700** HP

U./MIN:

APPLIC.: **NAUTICA**

SERV:

CODICE: **KLMT3248-**

30927



ROTAZIONE V.L.A.: Entrambi i sensi

∅ 114 X 160 morsi 3

CARR.: **SALPAANCORE ARGANO**

MOTORE: **CIMA**

TIPO: **30927 - Albero d.14**

ARM. V1: **24** A1:

ECC.: **SERIE**

V2: A2:

KW: **1,200** HP

U./MIN: **3000**

APPLIC.: **NAUTICA**

SERV:

CODICE: **KLMT3309-**

30542



ROTAZIONE V.L.A.: Entrambi i sensi

∅ 82 X 142 morsi 3

CARR.: **SALPAANCORE ARGANO**

MOTORE: **CIMA**

TIPO: **30542 - Fl. Quad. Alb. d.11**

ARM. V1: **24** A1: **0**

ECC.: **M. PERMANENTE**

V2: A2:

KW: **0,300** HP

U./MIN:

APPLIC.: **NAUTICA**

SERV:

CODICE: **KLMT3245-**

30554



ROTAZIONE V.L.A.: Entrambi i sensi

∅ 114 X 160 morsi 3

CARR.: **SALPAANCORE ARGANO**

MOTORE: **CIMA**

TIPO: **30554 - Albero d.14**

ARM. V1: **24** A1:

ECC.: **SERIE**

V2: A2:

KW: **1,000** HP

U./MIN: **3000**

APPLIC.: **NAUTICA**

SERV:

CODICE: **KLMT3251-**

30390



ROTAZIONE V.L.A.: Entrambi i sensi

∅ 127 X 213 morsi 3

CARR.: **SALPAANCORE ARGANO**

MOTORE: **CIMA**

TIPO: **30390 - Albero d.19**

ARM. V1: **24** A1: **88**

ECC.: **SERIE**

V2: A2:

KW: **1,500** HP

U./MIN: **2200**

APPLIC.: **NAUTICA**

SERV:

CATALOGO MOTORI



SRL

CODICE: **KLMT3259-**

30393

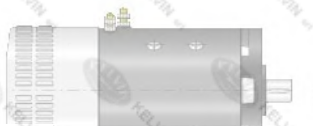
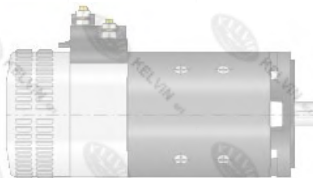

ROTAZIONE V.L.A.: Entrambi i sensi

Ø 150 X 0 morsi 3

CARR.: **SALPAANCORE ARGANO**

MOTORE: **CIMA**

TIPO: **30393- Albero d.28**

ARM. V1: **24** A1:

ECC.: **SERIE**

V2: A2:

KW: **2,500** HP

U./MIN: **3000**

APPLIC.: **NAUTICA**

SERV:

CODICE: **KLMT3247-**

30567



ROTAZIONE V.L.A.: Entrambi i sensi

Ø 114 X 175 morsi 3

CARR.: **SALPAANCORE ARGANO MA**

MOTORE: **CIMA**

TIPO: **30567- Albero d.14**

ARM. V1: **24** A1: **69**

ECC.: **SERIE**

V2: A2:

KW: **1,200** HP

U./MIN: **3400**

APPLIC.: **NAUTICA**

SERV:

CODICE: **KLMT3252-**

30905

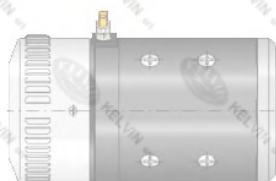
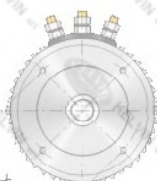

ROTAZIONE V.L.A.: Entrambi i sensi

Ø 127 X 0 morsi 3

CARR.: **SALPAANCORE ARGANO**

MOTORE: **CIMA**

TIPO: **30905- Albero d.14**

ARM. V1: **24** A1:

ECC.: **SERIE**

V2: A2:

KW: **1,500** HP

U./MIN: **3000**

APPLIC.: **NAUTICA**

SERV:

CODICE: **KLMT3254-**

30371



ROTAZIONE V.L.A.: Entrambi i sensi

Ø 126 X 210 morsi 3

CARR.: **SALPAANCORE ARGANO**

MOTORE: **CIMA**

TIPO: **30371- Albero d.17**

ARM. V1: **24** A1:

ECC.: **SERIE**

V2: A2:

KW: **1,500** HP

U./MIN: **3000**

APPLIC.: **NAUTICA**

SERV:

CODICE: **KLMT3255-**

30341

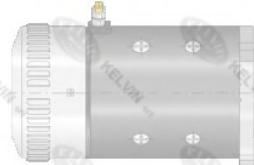
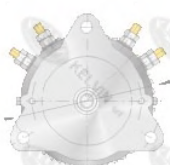

ROTAZIONE V.L.A.: Entrambi i sensi

Ø 127 X 0 morsi 4

CARR.: **SALPAANCORE ARGANO**

MOTORE: **CIMA**

TIPO: **30341- Albero d.14**

ARM. V1: **24** A1:

ECC.: **SERIE**

V2: A2:

KW: **2,000** HP

U./MIN: **3000**

APPLIC.: **NAUTICA**

SERV:

CATALOGO MOTORI



CODICE:

KLMT3256-

30381

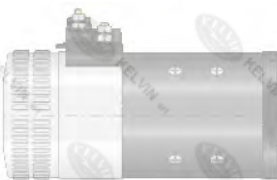

ROTAZIONE V.L.A.: Entrambi i sensi

Ø 150 X 0 morsi 3

CARR.: **SALPAANCORE ARGANO**

MOTORE: **CIMA**

TIPO: **30381- Albero d.19**

ARM. V1: **24** A1:

ECC.: **SERIE**

V2: A2:

KW: **2,000** HP

U./MIN: **3000**

APPLIC.: **NAUTICA**

SERV:

CODICE:

KLMT3258-

MCA2024M



ROTAZIONE V.L.A.: Entrambi i sensi

Ø 150 X 295 morsi 3

CARR.: **SALPAANCORE LOFRANS**

MOTORE: **CIMA**

TIPO: **30394- Albero d.28**

ARM. V1: **24** A1:

ECC.: **SERIE**

V2: A2:

KW: **2,000** HP

U./MIN: **3000**

APPLIC.: **NAUTICA**

SERV:

CODICE:

KLMT3260-

30392



ROTAZIONE V.L.A.: Entrambi i sensi

Ø 150 X 0 morsi 4

CARR.: **SALPAANCORE ARGANO**

MOTORE: **CIMA**

TIPO: **30392- Albero d.30**

ARM. V1: **24** A1:

ECC.: **SERIE**

V2: A2:

KW: **3,500** HP

U./MIN: **3000**

APPLIC.: **NAUTICA**

SERV:

CODICE:

KLMT3262-

30592



ROTAZIONE V.L.A.: Entrambi i sensi

Ø 82 X 0 morsi 2

CARR.: **SALPAANCORE ARGANO**

MOTORE: **CIMA**

TIPO: **30592- Albero d.11**

ARM. V1: **24** A1: **0**

ECC.: **M. PERMANENTE**

V2: A2:

KW: **0,400** HP

U./MIN:

APPLIC.: **NAUTICA**

SERV:

CODICE:

KLMT3381-

30565



ROTAZIONE V.L.A.: Entrambi i sensi

Ø 114 X 165 morsi 3

CARR.: **SALPAANCORE ARGANO MA**

MOTORE: **CIMA**

TIPO: **30565- Albero d.14**

ARM. V1: **24** A1: **60**

ECC.: **SERIE**

V2: A2:

KW: **1,000** HP

U./MIN: **3200**

APPLIC.: **NAUTICA**

SERV: **INT.**

CATALOGO MOTORI



SRL

CODICE: **KLMT2659-**

30552



ROTAZIONE V.L.A.: Entrambi i sensi

Ø 114 X 165 mors 3

CARR.: **SALPAANCORE ARGANO**

MOTORE: **CIMA**

TIPO: **30552**

ARM. V1: **24** A1: **60**

ECC.: **SERIE**

V2: A2:

KW: **1** HP

U./MIN: **3200**

APPLIC.: **NAUTICA**

SERV:

CODICE: **KLMT2683-**

30558



ROTAZIONE V.L.A.: Entrambi i sensi

Ø 114 X 175 mors 3

CARR.: **SALPAANCORE ARGANO**

MOTORE: **CIMA**

TIPO: **30558**

ARM. V1: **24** A1: **69**

ECC.: **SERIE**

V2: A2:

KW: **1,200** HP

U./MIN: **3400**

APPLIC.: **NAUTICA**

SERV:

CODICE: **KLMT3257-**

30373

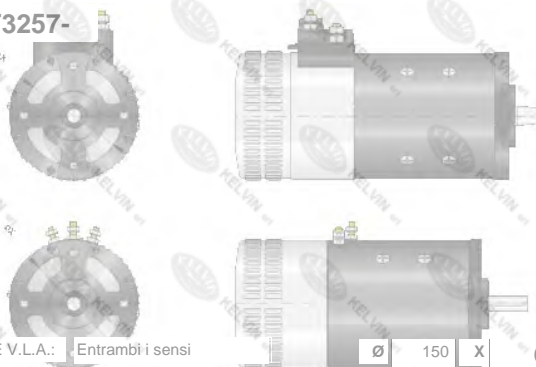

ROTAZIONE V.L.A.: Entrambi i sensi

Ø 150 X 0 mors 3

CARR.: **SALPAANCORE ARGANO**

MOTORE: **CIMA**

TIPO: **30373- Albero C.1:5**

ARM. V1: **24** A1:

ECC.: **SERIE**

V2: A2:

KW: **2,500** HP

U./MIN: **3000**

APPLIC.: **NAUTICA**

SERV:

CODICE: **KLMT2788-**

6000189



ROTAZIONE V.L.A.: Entrambi i sensi

Ø 112 X 151 mors 3

CARR.: **SALPAANCORE LEWMAR MA**

MOTORE: **ISKRA**

TIPO: **AMJ4789<=>T**

ARM. V1: **12** A1:

ECC.: **SERIE**

V2: A2:

KW: **0,700** HP

U./MIN: **1500**

APPLIC.: **NAUTICA**

SERV: **S3 - 7%**

CODICE: **KLMT2133-**

11028



ROTAZIONE V.L.A.: Entrambi i sensi

Ø 112 X 170 mors 3

CARR.: **SALPAANCORE LOFRANS**

MOTORE: **SALPAANCORE**

TIPO: **112 3MO CIL.17 PL7**

ARM. V1: **24** A1:

ECC.: **SERIE**

V2: A2:

KW: **1** HP

U./MIN: **2900**

APPLIC.: **NAUTICA**

SERV: **S2-10MIN.**