

ARTICOLO: **KLCM1002-000**

50027254 + + 50027255



PIATTINA
PIATTINA

FIELD COIL SET + INTERPOLE
COIL SET

ARTICOLO: **KLCM1003-000**

3233572000

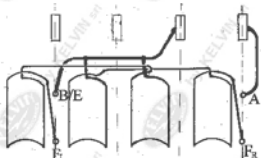

PIATTINA
PIATTINA

TR.LINDE E15 1°

ARTICOLO: **KLCM1009-000**

3253572000

50007766



PIATTINA
PIATTINA

TR. LINDE E25 1°

ARTICOLO: **KLCM1010-000**



PIATTINA NUDA

SERIE CAMPI x TR.LINDE 3a
0009761115

ARTICOLO: **KLCM1012-000**



PIATTINA NUDA

TR.LINDE E30-336

ARTICOLO: **KLCM1013-000**

S28T



PIATTINA
PIATTINA

ARTICOLO: **KLCM1014-000**

3253572020

3253570300

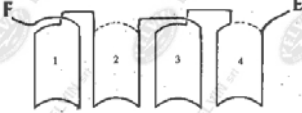

PIATTINA
PIATTINA

TR.LINDE E25 2°

ARTICOLO: **KLCM1016-000**

S20T



PIATTINA
PIATTINA

TR.PGS X S20T

ARTICOLO: **KLCM1017-000**

077943F



PIATTINA NUDA
PIATTINA NUDA

TR.STILL R14 L. PACCO 140
X077943f

ARTICOLO: **KLCM1018-000**

3243570315



PIATTINA
NOI PIATTINA

EP. LINDE - STILL x GP116-
14/5,5

ARTICOLO: **KLCM1019-000**

3243572000 50007203



FILO
FILO

FELDSPULENSATZ 100-
6.100/104

ARTICOLO: **KLCM1020-000**

3243572005 50007209

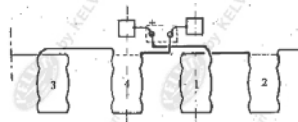

FILO

ARTICOLO: **KLCM1021-000**

3253570305 0328222-3-5
275710-708-703

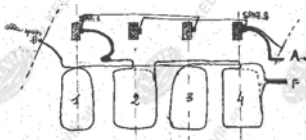

FILO
PIATTINA

serie Bobine: 3253505505

ARTICOLO: **KLCM1022-000**

3253572015 50007328

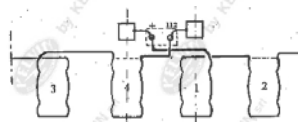

FILO
FILO

FIELD COIL SET

ARTICOLO: **KLCM1023-000**

5010336 50045664
40990277



MAGNETE PERMANENTE x
MBT1141L

ARTICOLO: **KLCM1024-000**

3243570310*



PIATTINA
FILO

* x LINDE = STATORE
COMPLETO

ARTICOLO: **KLCM1025-000**

3243572001 50007214



FILO

SERIE CAMPI

ARTICOLO: **KLCM1026-000**

3243572006 50007215



FELDSPULENSATZ 100-6

ARTICOLO: **KLCM1027-000**

3223572000 50007338



FILO
FILO

SS.LINDE E16 P

ARTICOLO: **KLCM1029-000**

S16T



PIATTINA
PIATTINA

TR. PME S16T

ARTICOLO: **KLCM1030-000**



PIATTINA
PIATTINA

EP.BKB x 4003483-004 -
NELCO4003284

ARTICOLO: **KLCM1032-000**

299517

50007206



FIELD COIL SET

ARTICOLO: **KLCM1034-000**



PIATTINA NUDA

EP.LINDE336 80V. 13,5KW

ARTICOLO: **KLCM1035-000**

50007189



EP.LANSING-LINDE T20 x
D100/1,2R-105/107

ARTICOLO: **KLCM1036-000**

50007549



FELDSPULENSATZ 150-6

ARTICOLO: **KLCM1039-000**

50034040



FIELD COIL SET

ARTICOLO: **KLCM1041-000**

12SPIRE

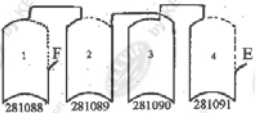

PIATTINA NUDA
PIATTINA NUDA

TR STILL R6006 LUNGO
12SPIRE

ARTICOLO: **KLCM1043-000**

3253572010

50007240



PIATTINA
FILO

SS. LINDE E25 1°

ARTICOLO: **KLCM1046-000**

x0009761171 R14 - R16



PIATTINA NUDA

EP.LINDE-STILL 48V. JULI
GP116-14/7,9

ARTICOLO: **KLCM1050-000**

9835675 028808

050301033A



PIATTINA

TR.AMRE 244 4MO CESAB - OM-RTL

ARTICOLO: **KLCM1051-000**



PIATTINA
PIATTINA

TR.HYSTER x BKB370049

ARTICOLO: **KLCM1064-000**

050302027



PIATTINA
FILO

EP. 5000W. 48V.177R 2VEL 3MO
PIMESPO

ARTICOLO: **KLCM1067-000**

2134114012	2134114013
2134104013	2134104014



EP.BH.112 OLD 24V, 2000W

ARTICOLO: **KLCM1074-000**



FILO
FILO

SS.LANSING x 4024350-001

ARTICOLO: **KLCM1076-000**



PIATTINA

TR. CLARK AU1829

ARTICOLO: **KLCM1091-000**



PIATTINA

TR.CIMA 24V d.110

ARTICOLO: **KLCM1093-000**



PIATTINA

TR.CIMA 12V d.110

ARTICOLO: **KLCM1095-000**

050301027



PIATTINA

TR.ORMIC - NACCO

ARTICOLO: **KLCM1100-000**

2134114031	2134104053
2134104054	



FILO
PIATTINA

EP. BH 0136355070

ARTICOLO: **KLCM1103-000**

50039205



HOUSING WITH MAGNETS

ARTICOLO: **KLCM1111-000**

050301009

050301009

PIATTINA

CAMPO TR. 2KW

ARTICOLO: **KLCM1115-000**

0384188 **50007848**

PIATTINA

FIELD-COIL-SET

ARTICOLO: **KLCM1123-000**

14180-21401-71

PIATTINA
PIATTINA

TR.TOYOTA 36/48

ARTICOLO: **KLCM1139-000**

2134116072

16500790

PIATTINA

EP. 48V

ARTICOLO: **KLCM1147-000**

NF

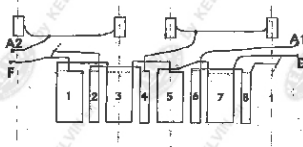

PIATTINA
PIATTINA

T 29C

ARTICOLO: **KLCM1169-000**

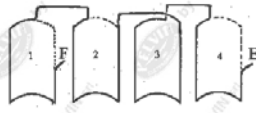

PIATTINA NUDA
PIATTINA NUDA

R6006 CORTO lento

ARTICOLO: **KLCM1170-000**



PIATTINA

TR. YALE x258040800

ARTICOLO: **KLCM1171-000**



PIATTINA
NOI PIATTINA

EP.YALE 80V.

ARTICOLO: **KLCM1173-000**

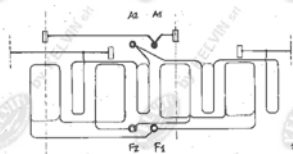

PIATTINA
PIATTINA

TR. X 258377300

ARTICOLO: **KLCM1175-000**

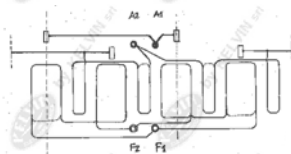

PIATTINA
PIATTINA

tr.yale

ARTICOLO: **KLCM1190-000**

4886T/2B



FILO

SERIE CAMPI EP.CESAB
4886T/2B

ARTICOLO: **KLCM1191-000**

4837M/1A.2

3608350

B4837



SERIE CAMPI TR.CESAB
4837M/1A.2

ARTICOLO: **KLCM1196-000**

308570

264805-264806 264807-264808

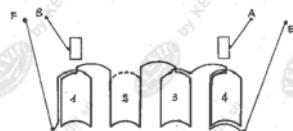

PIATTINA

SERIE CAMPI X TR R50

ARTICOLO: **KLCM1197-000**

328212-328213 328214-328215

3223571005

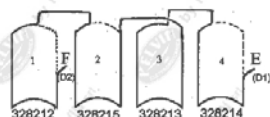

PIATTINA NUDA

TR.STILL R6011-R6016

ARTICOLO: **KLCM1198-000**

301690 - 301691 275682



PIATTINA
FILO

EP. R6016

ARTICOLO: **KLCM1199-000**

320029-30-31-32 275655-251266

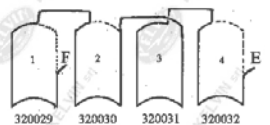

PIATTINA NUDA
PIATTINA NUDA

R6006 CORTO

ARTICOLO: **KLCM1201-000**

3243572010 3243570300
50046458



PIATTINA NUDA

TR. LINDE24v. 5°

ARTICOLO: **KLCM1202-000**

3243572015
50046397

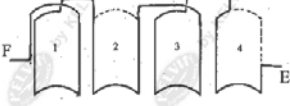

PIATTINA

TR. 48v.LINDE

ARTICOLO: **KLCM1218-000**

B7227M/1A B7227M/1A



7227M.1A.1-.32

ARTICOLO: **KLCM1230-000**

4302448
50007838



PIATTINA

SCHABMULLER FIELD COIL SET 210-6.268/166

ARTICOLO: **KLCM1231-000**

50007550



PIATTINA

FIELD COIL SET

ARTICOLO: **KLCM1234-000**

2134117023
16500816



PIATTINA

TR. CLARK-BOSCH - EXCITATION WINDING

ARTICOLO: **KLCM1237-000**

16500825 16500825
16500826 16500809



PIATTINA
FILO

EP.BH
2134117013+2134107001+2134107002

ARTICOLO: **KLCM1238-000**

372488



FILO
NOIFILO

TR.R60 NT - TR.OM XE40

ARTICOLO: **KLCM1240-000**



00F91Z8395A

STATORE MAGNETE
PERMANENTE x TAP11

ARTICOLO: **KLCM1252-000**

3C7103

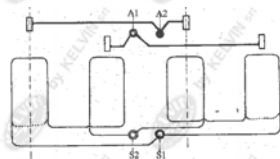

PIATTINA

TR. CAT MC30 x 3C7103

ARTICOLO: **KLCM1261-000**

1025339



PIATTINA
PIATTINA

SERIE CAMPI

ARTICOLO: **KLCM1284-000**

50025754



FILO

TR. FM14

ARTICOLO: **KLCM1287-000**

50027511



FILO

SS.WAGNER FM14 - FM20
(FIELD COIL SET)

ARTICOLO: **KLCM1289-000**

4307529



50007697

PIATTINA

FIELD COIL SET

ARTICOLO: **KLCM1290-000**

50001808



MAGNETE PERMANENTE

ARTICOLO: **KLCM1292-000**

4307480



50007679

PIATTINA

FIELD COIL-SET 178-6.521/569

ARTICOLO: **KLCM1296-000**



PIATTINA

TR.PIATTAFORMA SIMON-
BOXER170E

ARTICOLO: **KLCM1300-000**



48101T/3A

B48101

FILO

EP.CESAB 48101T.3A.3 =
4883T/3A

ARTICOLO: **KLCM1310-000**



50001791

STATOR MP100 x P102/

ARTICOLO: **KLCM1325-000**



50001877

STATOR M.P.

ARTICOLO: **KLCM1330-000**

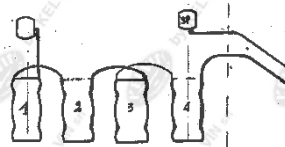

276207

50031240

FILO

SS R60

ARTICOLO: **KLCM1331-000**



50007765

PIATTINA

FELDSPULENSATZ 210-6.6/6

ARTICOLO: **KLCM1334-000**

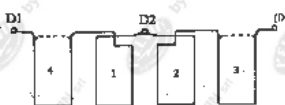

50007543

PIATTINA

ARTICOLO: **KLCM1337-000**



50023914

PIATTINA

FIELD COIL SET

ARTICOLO: **KLCM1340-000**



50007668

PIATTINA

TR. LANSING R178/2-

ARTICOLO: **KLCM1343-000**



50001810

STATOR 112

ARTICOLO: **KLCM1348-000**

0992243

50029017



PIATTINA

TR. CESAB

ARTICOLO: **KLCM1355-000**



50007216

SS. WAGNER x EFSM 48V.

ARTICOLO: **KLCM1356-000**

50037180

50037180



PIATTINA

FIELD COIL SET125-6.561/554

ARTICOLO: **KLCM1368-000**



050302026

PIATTINA

FILO

EP. 5000W. 80V.177 2VEL 3MO

ARTICOLO: **KLCM1372-000**



50007619

PIATTINA

FELDSPULENSATZ

ARTICOLO: **KLCM1376-000**



50007765

PIATTINA

NOI PIATTINA

TR. SIBICAR 72V.

ARTICOLO: **KLCM1382-000**

7291H/4A
B7291I/4A B7291H/4A

FILO

SERIE CAMPI CESAB
7291H/4A - I/4A



ARTICOLO: **KLCM1384-000**

50007308

PIATTINA

FIELD COIL-SET 112



ARTICOLO: **KLCM1387-000**

8400386-7-8-9

PIATTINA NUDA

TR. WAGNER RT

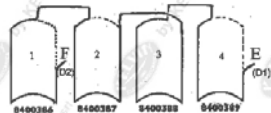

ARTICOLO: **KLCM1389-000**

2134116071

PIATTINA

EP.



ARTICOLO: **KLCM1393-000**

50007875+ +50008174

PIATTINA
PIATTINA

8 bobine (4+4)



ARTICOLO: **KLCM1394-000**

80201II.6A.2

FILO

SS. CESAB 80201 II.6A.2



ARTICOLO: **KLCM1398-000**

50007433

PIATTINA
PIATTINA

tr. Schab. \ Sibic



ARTICOLO: **KLCM1400-000**

2134116068
8402564 16500823

PIATTINA

TR. BH. 24V. 2100W.



ARTICOLO: **KLCM1401-000**

1376851



PIATTINA
PIATTINA

TR. HYSTER E2.50XM x 8500458

ARTICOLO: **KLCM1404-000**

9002321-22 050302003



PIATTINA

CAMPO EL. 2,5KW 24V 150

ARTICOLO: **KLCM1409-000**

916020

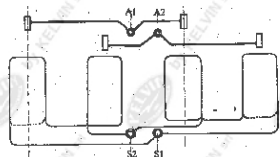

PIATTINA

TR. CAT F50D

ARTICOLO: **KLCM1410-000**

916220

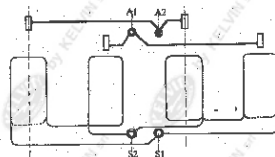

PIATTINA
PIATTINA

TR. CAT. 913148

ARTICOLO: **KLCM1413-000**

916370



PIATTINA
FILO

ARTICOLO: **KLCM1416-000**

926011



PIATTINA

TR. CAT

ARTICOLO: **KLCM1418-000**

928969

MKN2171A



PIATTINA

SERIE CAMPI TR.CAT F30

ARTICOLO: **KLCM1420-000**

9291101 9817022

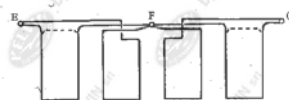

FILO

TR. ANSALDO TCUS25T

ARTICOLO: KLCM1421-000

8997839 9002303-4
050301008

PIATTINA

*TR.1000W 24V -MTX11-
BH.Vecchio*



ARTICOLO: KLCM1424-000

9004373 9817019

PIATTINA

E112 MSP

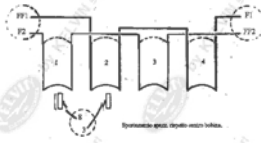

ARTICOLO: KLCM1427-000

9817024

FILO

*SERIE CAMPI X TR. ANSALDO
72v. KIT096*

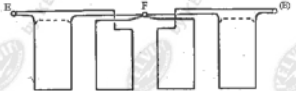

ARTICOLO: KLCM1429-000

9816457

**PIATTINA
PIATTINA**

CAMPO MTX13



ARTICOLO: KLCM1432-000

9819267 9836437
2134116067 16500822

BH.1100W. 24V.



ARTICOLO: KLCM1435-000

9817898 -981789 2134106009

**FILO
FILO**

SS. 053



ARTICOLO: KLCM1436-000

9817883 2134117016
16500840

**PIATTINA
PIATTINA**

*EP.OM BOSCH.602011
AMT4620 =>F*



ARTICOLO: KLCM1437-000

9817869 2134116092
16500841

PIATTINA

TR. E15N



ARTICOLO: **KLCM1438-000**

9819181

K12BL004A

FILO

STATORE K2T126 ECC. SERIE

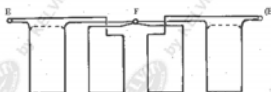

ARTICOLO: **KLCM1439-000**

9819269

2134116070

PIATTINA

EP. OM E10N



ARTICOLO: **KLCM1447-000**

9818732

K10BL002A

FILO

GIEM K2P104A



ARTICOLO: **KLCM1448-000**

9831986

FILO

X OM = carcassa con bobine



ARTICOLO: **KLCM1449-000**

9831993

PIATTINA

X OM: = carcassa con bobine



ARTICOLO: **KLCM1454-000**

9840308

K12BL006A

FILO

K2T126 ECC. INDIPENDENTE (SEPARATA)



ARTICOLO: **KLCM1458-000**

9840936* 9840937

K08BL006A K08BE005A*

FILO

TR.EU 15



ARTICOLO: **KLCM1468-000**

050301012

PIATTINA

TR. RTL 13 - 3,5KW.



ARTICOLO: **KLCM1472-000**

50007691
50007691

PIATTINA
FIELD COIL SET

ARTICOLO: **KLCM1476-000**

50029191

STATOR - MAGNETE PERMANENTE

ARTICOLO: **KLCM1533-000**

281088-89-90-91 20133

PIATTINA NUDA
PIATTINA NUDA
TR STILL R6006 LUNGO

ARTICOLO: **KLCM1536-000**

PIATTINA
tr.SI2TA - SI2T

ARTICOLO: **KLCM1537-000**

PIATTINA
PIATTINA
SI3T

ARTICOLO: **KLCM1545-000**

TF15

PIATTINA
TR.LE ROY TF15 X PIATTAFORMA

ARTICOLO: **KLCM1555-000**

2134115023

PIATTINA
TR. X 0136402007 PIM.125

ARTICOLO: **KLCM1562-000**

16280731
16280905

STATOR

ARTICOLO: **KLCM1599-000**

7282T/1B 3638227
B7282T/1B

FILO
FILO

SERIE CAMPI CESAB 7282T/1B

ARTICOLO: **KLCM1602-000**

50027737

STATOR125 MP

ARTICOLO: **KLCM1603-000**

050301037

PIATTINA

CAMPO TR. 4,9KW 48V 177 4MO

ARTICOLO: **KLCM1605-000**

B4844N/2A

SERIE CAMPI CESAB 4844N/2A

ARTICOLO: **KLCM1606-000**

48203 B48204.11.6A3

FILO

SS.CESAB 48204 II.6A.3

ARTICOLO: **KLCM1607-000**

50040877+ 50040878

PIATTINA
PIATTINA

REVERSINGPOL COIL + FIELD COIL SET

ARTICOLO: **KLCM1610-000**

50038740

STATOR M.P.

ARTICOLO: **KLCM1611-000**

7218M/1B/1 B7218M/1B

FILO

SERIE CAMPI CESAB7218M/1B/1

ARTICOLO: **KLCM1613-000**



PIATTINA

TR.TOYOTA 70V. 8KW.

ARTICOLO: **KLCM1617-000**



PIATTINA NUDA

EP.LINDE335

ARTICOLO: **KLCM1618-000**



PIATTINA

PIATTINA

TR CLARK 3790126

ARTICOLO: **KLCM1626-000**



50007761

PIATTINA

FIELD COIL SET

ARTICOLO: **KLCM1637-000**



7217A/1B

3638036

SERIE CAMPI TR.CESAB
7217A/1B

ARTICOLO: **KLCM1639-000**



7219N/1B

7219N-1B

3638029

SERIE CAMPI TR.CESAB
7219N/1B

ARTICOLO: **KLCM1644-000**



4814N/2A

3828110

FILO

SERIE CAMPI CESAB 4814N/2A

ARTICOLO: **KLCM1651-000**



7238N/1A/5

7238N/1D/1/26

B7238N/1A

FILO

SERIE CAMPI TIPO 7238N
5CAVI

ARTICOLO: **KLCM1653-000**

9815961 9817027

FILO
FILO

SS.ANSALDO PCUS1,5



ARTICOLO: **KLCM1658-000**

FILO

SS.PME S7P x PGS



ARTICOLO: **KLCM1663-000**

050301074 050301026

PIATTINA
NOI PIATTINA

TR. 12KW 72/80V 244L



ARTICOLO: **KLCM1665-000**

7291E/3A B7291E/3A

FILO

SERIE CAMPI CESAB 7291E/3A



ARTICOLO: **KLCM1675-000**

050301015

PIATTINA

TR.AMRE 177 5kW 6MO x 36-40-48V.



ARTICOLO: **KLCM1676-000**

50007673

PIATTINA

FIELD COIL SET 178-6.529/524



ARTICOLO: **KLCM1688-000**

50041833

FILO
FILO

FIELD COIL SET - SS.LINDE E48



ARTICOLO: **KLCM1693-000**

STA0101
ex.50001859 50038729

STATOR150 M.P.



ARTICOLO: **KLCM1697-000**



PIATTINA

EP. CLARK CEM30S R220/18RK

ARTICOLO: **KLCM1702-000**



050301017

PIATTINA

TR.48V.5kW.R.

ARTICOLO: **KLCM1713-000**



27888870

50007858

PIATTINA

FIELD COIL SET 210-6.361/237

ARTICOLO: **KLCM1717-000**



50038725

STATORE MP.

ARTICOLO: **KLCM1718-000**



50038812

FILO

FIELD COIL SET

ARTICOLO: **KLCM1726-000**



2134105017

16500787

FILO

FILO

SS.JUNGHEINRICH

ARTICOLO: **KLCM1727-000**



580010615

FILO

TR.YALE - GE-MOTOR 8500108

ARTICOLO: **KLCM1729-000**



FILO

TR.JULI GF116-Q7
JUNGHEINRICH

ARTICOLO: **KLCM1738-000**



50001837

STATOR (MAGNETE PERMANENTE)

ARTICOLO: **KLCM1750-000**

95320758

FILO

TR.JULI x GF084-G6

ARTICOLO: **KLCM1765-000**



16908416

FILO

TR.AMP2601 24V 2KW X ATLET

ARTICOLO: **KLCM1768-000**



PIATTINA
NOI PIATTINA

NACCO- BEST-
MOTORx F1263900

ARTICOLO: **KLCM1770-000**



2134126032+
+2134106016+ +2134106017

EP.BH 24V. 5,5KW

ARTICOLO: **KLCM1773-000**



PIATTINA

TR.OMG INOX x CA113.0071

ARTICOLO: **KLCM1774-000**



50039191

FILO

TR.CAT x N125/0,8-717/660

ARTICOLO: **KLCM1786-000**



50037053

PIATTINA

EP.YALE - NACCO

ARTICOLO: **KLCM1787-000**

50043701



TR.HYSTER - SCH.125

ARTICOLO: **KLCM1789-000**

50001796



STATOR - MAGNETE PERMANENTE

ARTICOLO: **KLCM1791-000**

050301037A



PIATTINA

CAMPO TR.5KW 48V 177 4MO

ARTICOLO: **KLCM1799-000**

50001796



PIATTINA NUDA

EP.STILLR6035NEW x GP164-M1

ARTICOLO: **KLCM1800-000**

50034884



STATORE M.P.

ARTICOLO: **KLCM1806-000**

50040387



PIATTINA

TR.SAMAG

ARTICOLO: **KLCM1808-000**

Y296321286

50007337



SS.YALE

ARTICOLO: **KLCM1809-000**

50007337



FILO

SS. MECCANICO MEZ S56F

ARTICOLO: **KLCM1811-000**

16908691

PIATTINA

EP.YALE - NACCO x 11216227

ARTICOLO: **KLCM1814-000**

50039163

FILO

FIELD COIL SET 150

ARTICOLO: **KLCM1817-000**

50038735

HOUSING WITH MAGNETS

ARTICOLO: **KLCM1821-000**

50044867

PIATTINA

SS.SCHABMULLER x PIMESPO
THESI

ARTICOLO: **KLCM1823-000**

50038491

PIATTINA
NOI PIATTINA

EP.LEROY X E40N

ARTICOLO: **KLCM1825-000**

0050993419 **50038491+**
+50038493 **50044754=>384**

FILO
PIATTINA

FIELD COIL SET + REVERSING
POLE COIL CPL

ARTICOLO: **KLCM1835-000**

9843681

PIATTINA

STATORE EP.LEROYx9459070
T17

ARTICOLO: **KLCM1840-000**

50038491

PIATTINA
NOI PIATTINA

EP.CAT-PRESTOLITE x 927570

ARTICOLO: **KLCM1842-000**

R014100009

50039217

STATOR MP

ARTICOLO: **KLCM1845-000**



**PIATTINA
NOI PIATTINA**

**TR.TTL225A-SERIES x
STEINBOCK**

ARTICOLO: **KLCM1848-000**



**MAGNETE PERMANENTE x 90-
35846-6**

4310796

ARTICOLO: **KLCM1854-000**



STATOR EP.ISKRA AMK

ARTICOLO: **KLCM1856-000**



FIELD COIL SET 112-6.725/676

ARTICOLO: **KLCM1857-000**



FILO

8049N.1B.1

TR.CESAB x 8049N.1B.1

ARTICOLO: **KLCM1862-000**



50041815 + 50052535

FILO

FIELD COIL SET250-6/10

ARTICOLO: **KLCM1863-000**



50001807

**STATOR 112- MAGNETE
PERMANENTE**

ARTICOLO: **KLCM1882-000**

50058628

FILO

TR.BLITZ320AC - STATOR AC
200



ARTICOLO: **KLCM1887-000**

50058628

FILO

TR.24V, 2600W. SEM



ARTICOLO: **KLCM1897-000**

6201515

STATORE MP AMER 84 X 125
2X50 4X50 H13



ARTICOLO: **KLCM1898-000**

50037195

PIATTINA

FIELD COIL SET 178-686



ARTICOLO: **KLCM1907-000**

50037195

PIATTINA

TR.DAEWOO x A154050



ARTICOLO: **KLCM1909-000**

50041417

PIATTINA

FIELD COIL SET



ARTICOLO: **KLCM1912-000**

S990467
EX.50053484 50059844

FILO

STATOR270 AC- TR.CESAB
Blitz250-300



ARTICOLO: **KLCM1919-000**

50001797

STATOR MP100 x P102/



ARTICOLO: **KLCM1920-000**

050301001

PIATTINA

TR.500W.



ARTICOLO: **KLCM1923-000**

50001848

STATOR MP



ARTICOLO: **KLCM1924-000**

PIATTINA
NOI PIATTINA

EP.HYSTER X 5BC49JB1124



ARTICOLO: **KLCM1927-000**

STATORE METALROTA x 113-
MP 400W



ARTICOLO: **KLCM1930-000**

16282213

PIATTINA

STATORE EP.



ARTICOLO: **KLCM1933-000**

PIATTINA
NOI PIATTINA

EP.CESAB 3MO



ARTICOLO: **KLCM1940-000**

6202805

TR.AMER MP80L



ARTICOLO: **KLCM1952-000**

FILO

TR.STILL CS20 / JULI ecc. sep.





ARTICOLO: **KLCM1960-000**

16907255

FILO

*TR.YALE ISKRA AC -
AVVOLGIMENTO-*



ARTICOLO: **KLCM1961-000**

50001842

STATOR MP



ARTICOLO: **KLCM1965-000**

50027264

*STATOR (MAGNETE
PERMANENTE)*



ARTICOLO: **KLCM1973-000**

156401

**FILO
NOI FILO**

*TR.LINDE335/STILLR20 NEW
48V.*



ARTICOLO: **KLCM1977-000**

925796

MPR2001

CARCASSA MAGNETI P.



ARTICOLO: **KLCM1979-000**

14303-F3070-71

FILO

*TOYOTA AC API ELMO
TSP160/4-250-T-12336*



ARTICOLO: **KLCM1985-000**

R014350088

50001890

STATORE M.P.



ARTICOLO: **KLCM1989-000**

50038710

HOUSING 150 - STATOR MP

ARTICOLO: **KLCM1995-000**

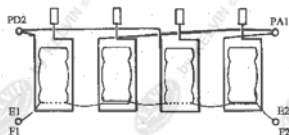

PIATTINA
FILO

ARTICOLO: **KLCM1999-000**



50001799

STATOR MP100 x P102/

ARTICOLO: **KLCM2010-000**



50001790

HOUSING WITH MAGNETS

ARTICOLO: **KLCM2014-000**



50049120

STATOR AC 200

ARTICOLO: **KLCM2023-000**



PIATTINA

TR.8&W LUNGO

ARTICOLO: **KLCM2031-000**



50001806

STATOR 112 MP

ARTICOLO: **KLCM2035-000**



PIATTINA
FILO

EP.STEINBOCK x GP116-F5

ARTICOLO: **KLCM2051-000**



FILO

CAMPI X TR.CESAB ALBERO
CAVO 4936002

ARTICOLO: **KLCM2064-000**

50039374

FILO

FIELD COIL SET 210-319 x TR.TCM



ARTICOLO: **KLCM2067-000**

6920393

TR.AMER MP80S/2



ARTICOLO: **KLCM2079-000**

2134116102 16500861

PIATTINA

TR.BH.076 HURTH NACCO



ARTICOLO: **KLCM2088-000**

16280555

**PIATTINA
FILO**

STATORE ISKRA AMK5639 - STILLEGV12



ARTICOLO: **KLCM2104-000**

72V.

FILO

TR.GE-MOTOR 8500..



ARTICOLO: **KLCM2130-000**

PIATTINA

TR.HURT RA210035



ARTICOLO: **KLCM2133-000**

AB-MP405-6200

**STATORE M.P. X SS.TCM
FB15H4**



ARTICOLO: **KLCM2134-000**

MPR2001E

CARCASSA MAGNETI P.



ARTICOLO: **KLCM2156-000**

50051022

FILO

FIELD COIL SET 115-6 x BT
LV13



ARTICOLO: **KLCM2169-000**

50040329

STATOR 150 M.P.



ARTICOLO: **KLCM2180-000**

48202.15A.1 48202.15A.1

FILO

SERIE CAMPI SS.CESAB
48202.15A.1



ARTICOLO: **KLCM2182-000**

16280939

STATOR EP.ISKRA AMK



ARTICOLO: **KLCM2228-000**

50001893

STATORE M.P.



ARTICOLO: **KLCM2230-000**

50070396

FRAME CPL. TSL/TTL140



ARTICOLO: **KLCM2240-000**

50057044

FILO

STATOR AC 106



ARTICOLO: **KLCM2241-000**

50059523

FILO

STATOR AC 106





ARTICOLO: **KLCM2248-000**

050301037B

PIATTINA

CAMPO TR.CARER -MA1400



ARTICOLO: **KLCM2249-000**

50052293

FILO

FIELD COIL SET 178-702



ARTICOLO: **KLCM2265-000**

50060142

FILO

TR.TSAI70AC - STATOR ACI70



ARTICOLO: **KLCM2306-000**

50001809

STATOR 112 MP